 STORA-DRAIN	Name: TOP B=100 H=65 L=1000
Material: polyester concrete	Class load: A15 - C250
Protective edge: -	Article number: ST10061000



Name:
TOP B=100 H=100 L=1000

Material:
polyester concrete

Class load:
A15 - C250

Protective edge:
-

Article number:
ST10101000

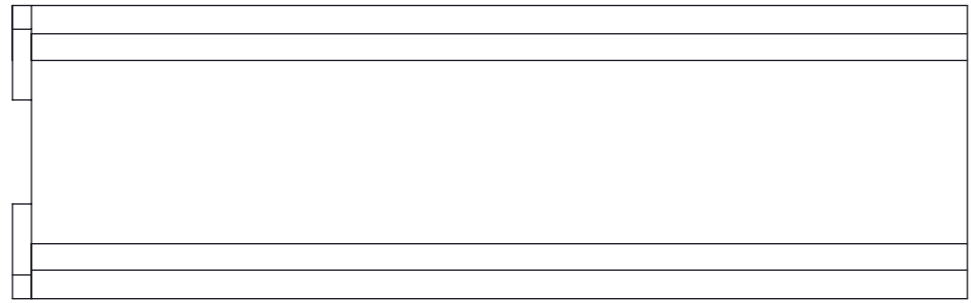
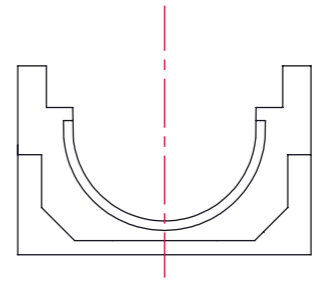
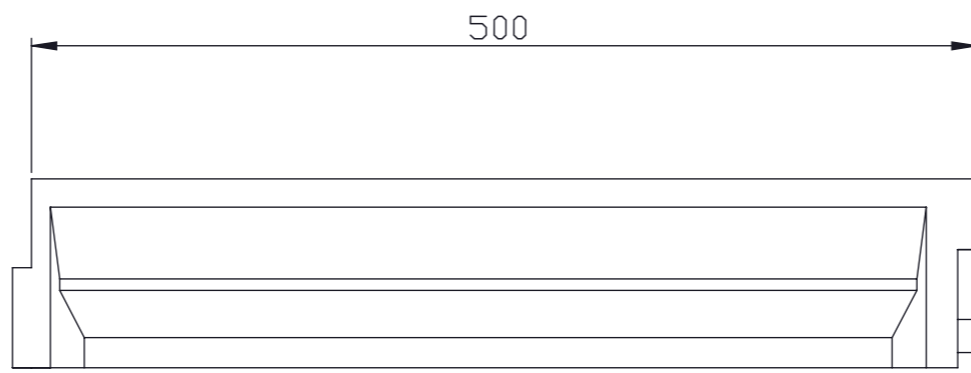
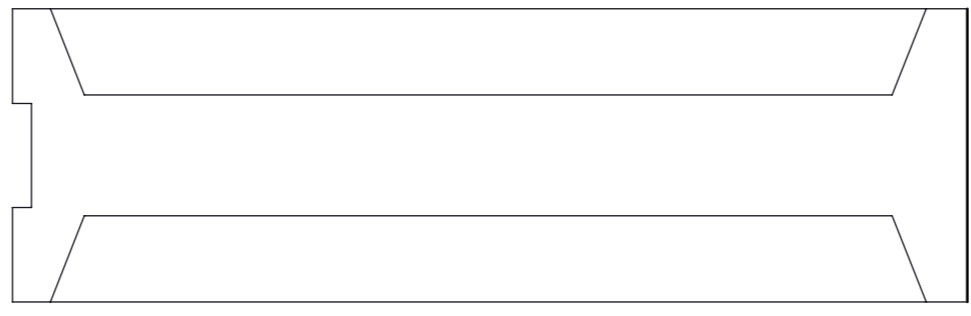
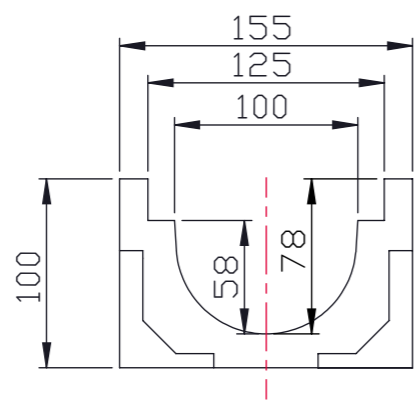

 STORA-DRAIN	Name: TOP B=100 H=100 L=500
Material: polyester concrete	Class load: A15 - C250
Protective edge: -	Article number: ST10105000

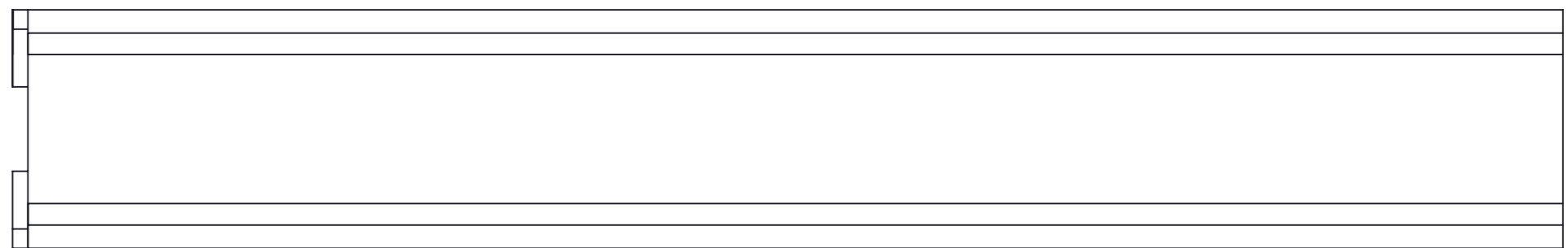
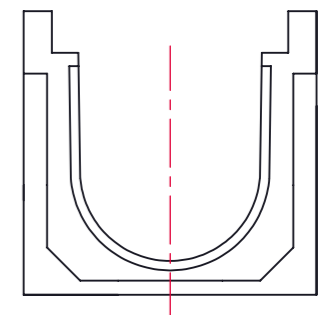
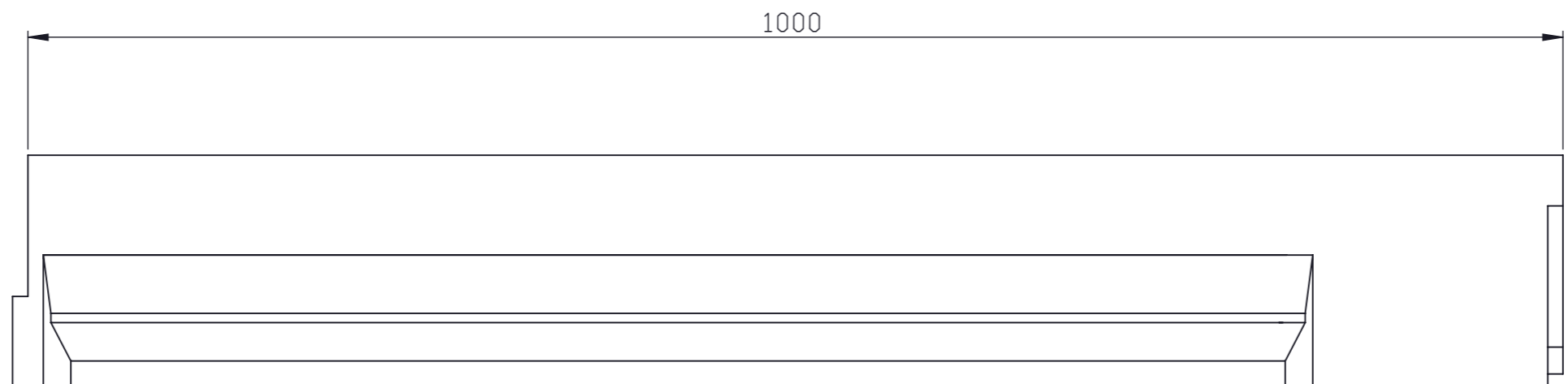
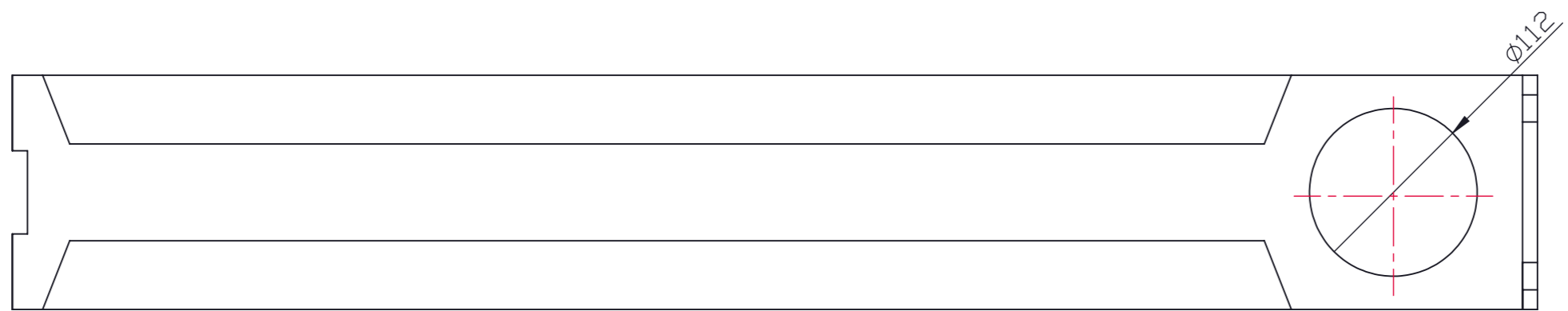
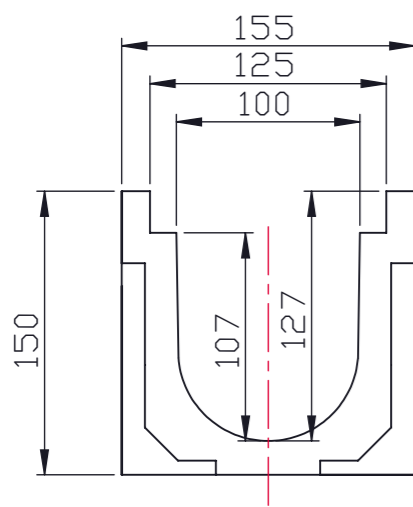

 STORA-DRAIN	Name:	TOP B=100 H=150 L=1000	
	Material:	polyester concrete	
	Class load:	A15 - C250	
Protective edge:	-	Article number:	ST10151000

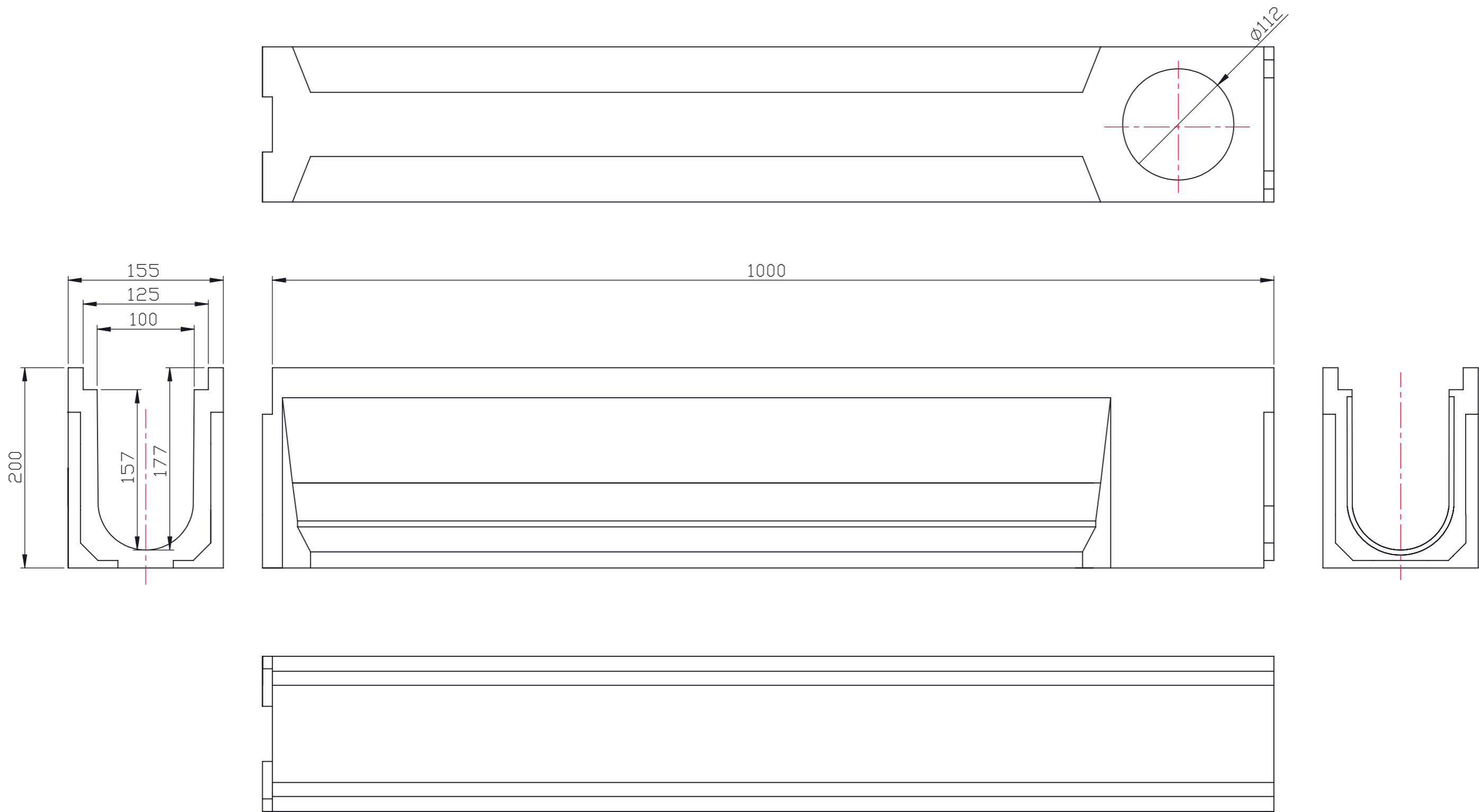

 STORA-DRAIN	Name: TOP B=100 H=200 L=1000
Material: polyester concrete	Class load: A15 - C250
Protective edge: -	Article number: ST10201000

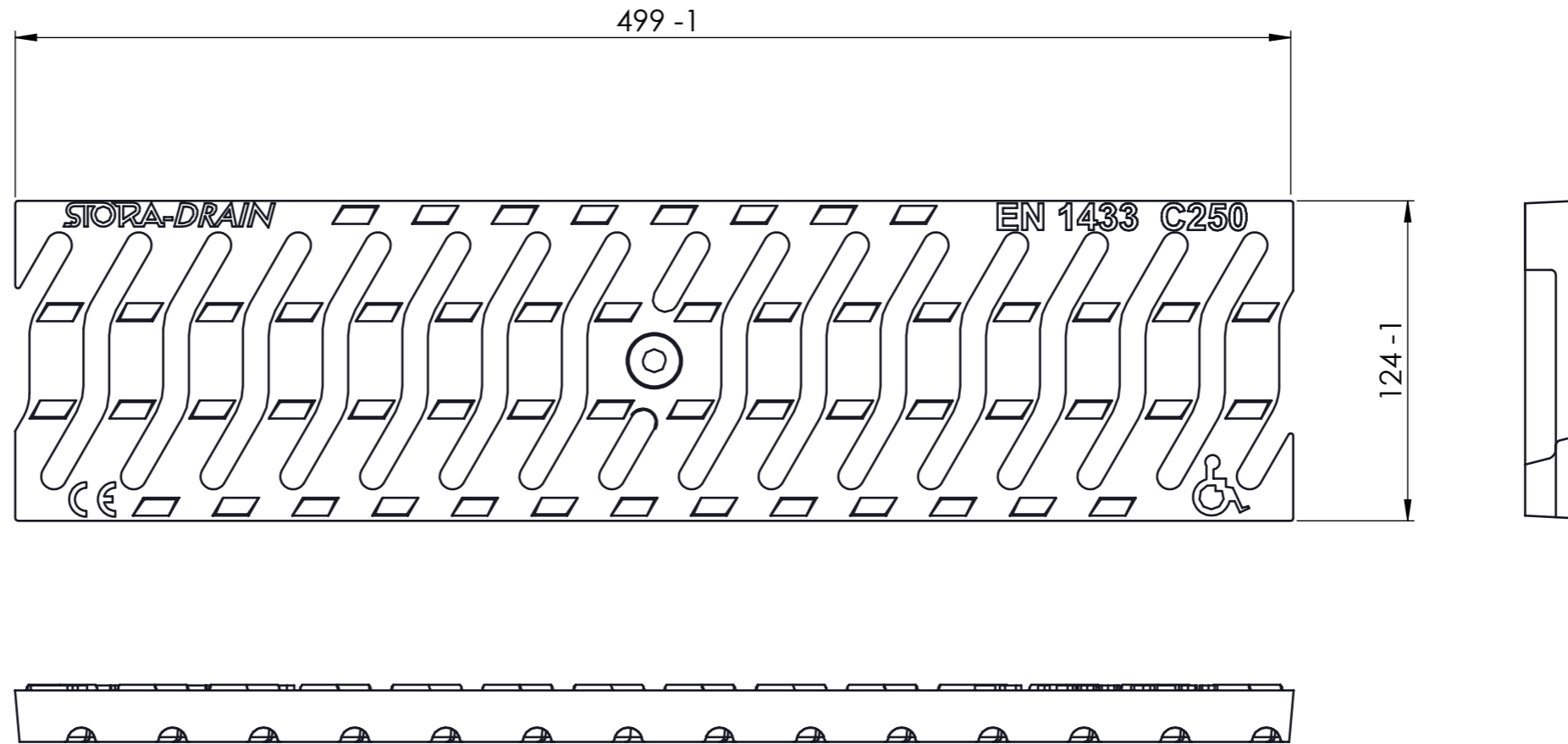
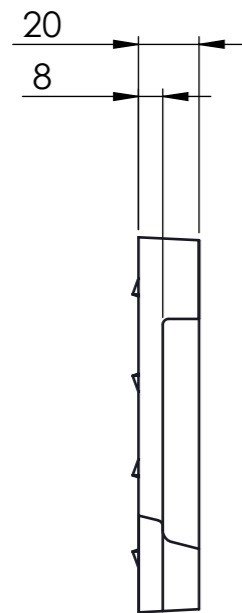

 STORA-DRAIN	Name: Grating PARKING B=100
Material: ductile iron	Class load: C250
Anchorage screw M8	Article number: RSP100C321