

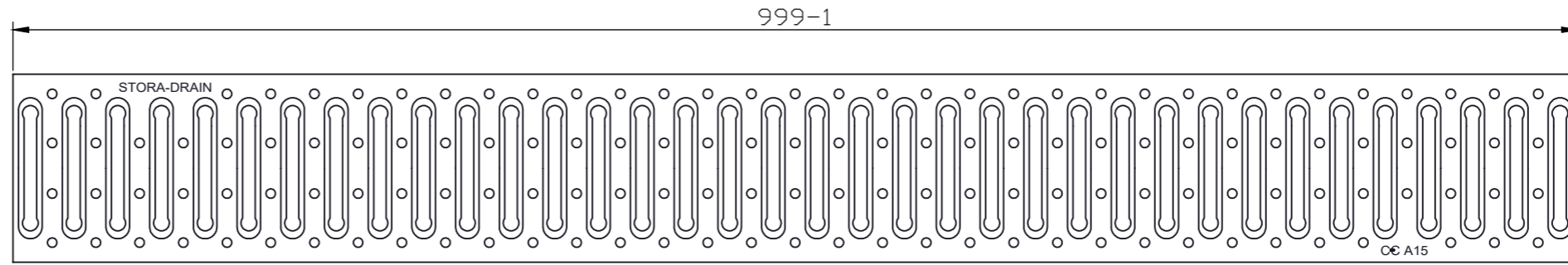

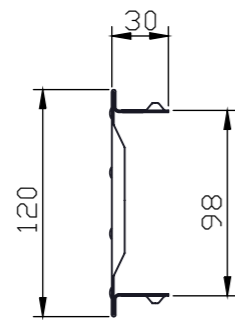

STORA-DRAIN

 STORA-DRAIN	Name: LIGHT B=100 H=80 L=1000
Material: polypropylene	Class load: A15
Protective edge: -	Article number: SL10081000

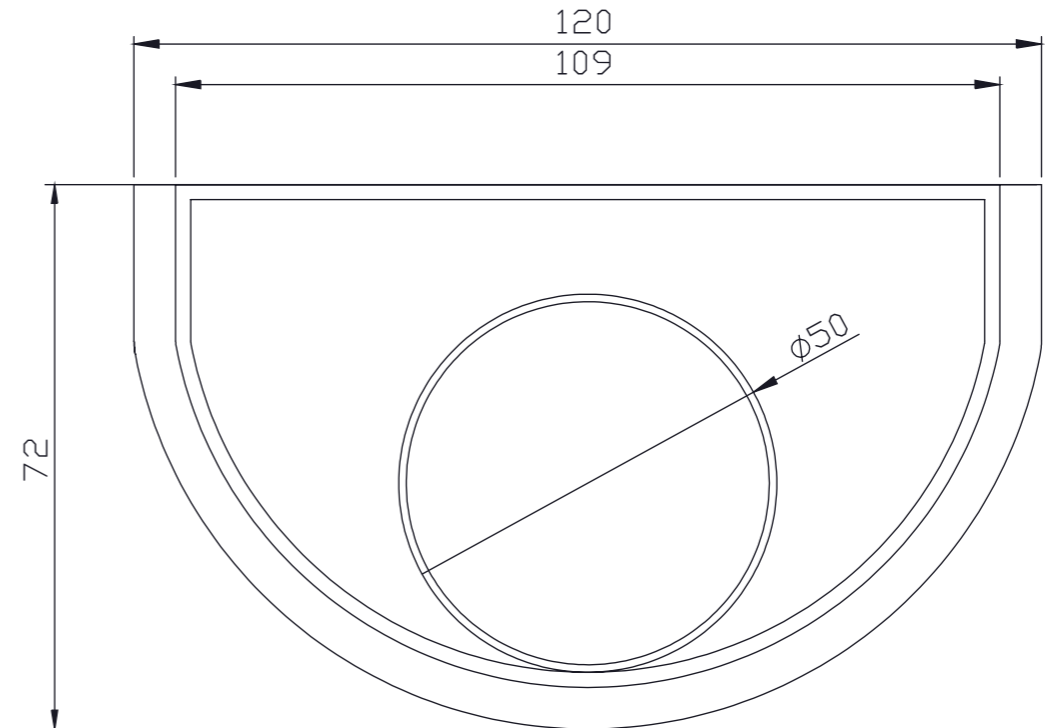
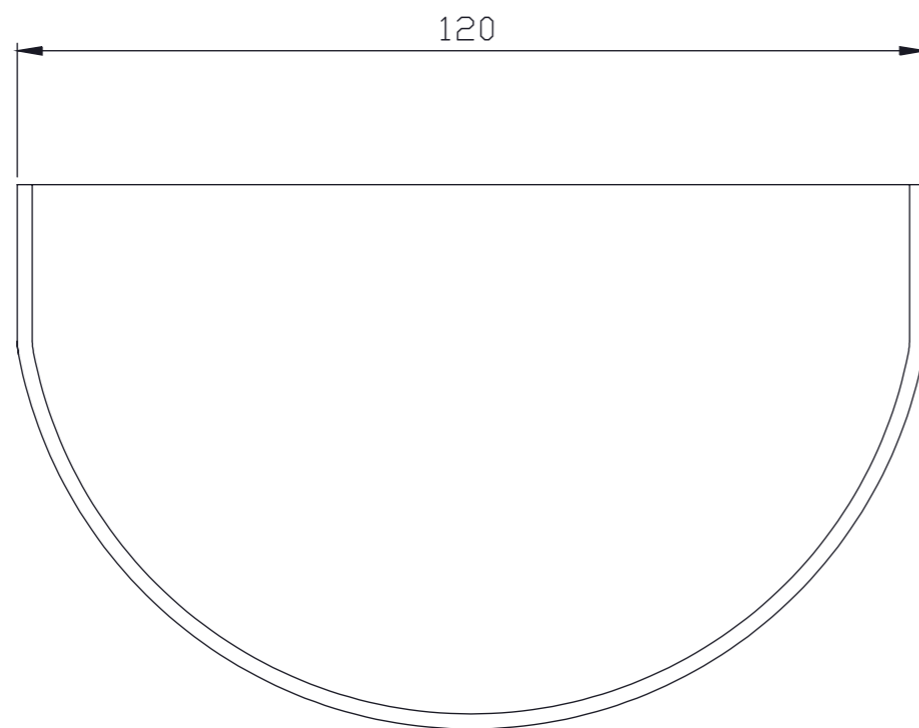

 STORA-DRAIN	Name: Grating galvanized slotted 10 mm SELF B=100
Material: galvanized steel sheet	Class load: A15
Anchorage: fix	Article number: RSE100A100



 STORA-DRAIN	Name: Front wall with exit LIGHT H=80
Material: PE	Anchorage: sealing mass
Protective edge: -	Article number: AE10001000